

Hoses

Polyurethane, rubber and “non-conductive”.

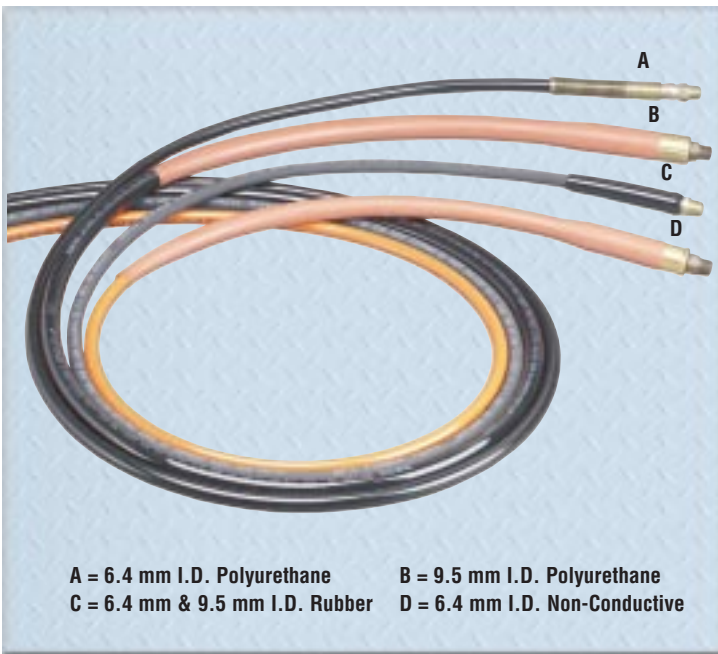

HOSES, FITTINGS, GAUGES

- There are five styles in lengths from 0.6 to 30.5 meters. All have plastic hose guards except for the 6.4 mm I.D. polyurethane hoses which have spring guards.
- All have 3/8" NPTF fittings on both ends.
- Operating pressure is 700 bar. All comply with MHI standard IJ100.

■ Polyurethane hose

Made up of nylon core tube with polyester fiber reinforcement which will withstand the minimum SAE bend radius without shortening service life. These hoses last up to seven times longer than rubber hose, and are suitable for continuous service at temperatures from -40° to 66° C.

■ Rubber hose

2-ply rated hose reinforced with two braids of high tensile steel wire. The rubber covering is oil and weather resistant. These hoses are MSHA approved.

■ Non-conductive hose

For applications requiring electrical isolation by the hose, “non-conductive” hose has a leakage factor of less than 50 microamperes, considered a safe level on conductivity by SAE standards. The covering is polyurethane and colored orange for easy identification as non-conductive hose. The covering is not perforated, preventing moisture from entering the hose and affecting its overall conductivity. All non-conductive hoses have a minimum burst pressure of 2,800 bar.

■ Hydraulic hose assembly

No. 9764 – Hose assembly consisting of 9767 (1.8 m hose), 6.4 mm I.D. polyurethane with 9798 hose half coupler and 9800 dust cap assembled.

No. 9754 – Hose assembly consisting of 9756 (1.8 m hose), 6.4 mm I.D. rubber with 9798 hose half coupler and 9800 dust cap assembled.

CYLINDER RETURN TIME

The figures show the relative effect two styles of hose can have on return time. Actual times may vary.

Cylinder	No. 9769	No. 9781
	3.1 m Hose 6.4 mm I.D.	3.1 m Hose 9.5 mm I.D.
C2514C	51 sec.	14 sec.
C556C	1 min., 30 sec.	24 sec.
C5513C	4 min., 12 sec.	59 sec.
C10010C	6 min., 56 sec.	1 min., 3 sec.

ORDERING INFORMATION

Hose Type	Hose I.D.	Hose Length	Burst Rating	Order No.
Polyurethane	6.4 mm	0.6 m	1,400 bar	9765
Polyurethane	6.4 mm	0.9 m	1,400 bar	9766
Polyurethane	6.4 mm	1.8 m	1,400 bar	9767
Polyurethane	6.4 mm	1.8 m	1,400 bar	9764*
Polyurethane	6.4 mm	2.4 m	1,400 bar	9768
Polyurethane	6.4 mm	3.1 m	1,400 bar	9769
Polyurethane	6.4 mm	3.7 m	1,400 bar	9770
Polyurethane	6.4 mm	6.1 m	1,400 bar	9771
Polyurethane	6.4 mm	15.3 m	1,400 bar	9772
Polyurethane	6.4 mm	22.9 m	1,400 bar	9750
Polyurethane	6.4 mm	30.5 m	1,400 bar	9751
Polyurethane	9.5 mm High Flow	1.8 m	2,100 bar	9780
Polyurethane	9.5 mm High Flow	3.1 m	2,100 bar	9781
Polyurethane	9.5 mm High Flow	6.1 m	2,100 bar	9782
Polyurethane	9.5 mm High Flow	15.3 m	2,100 bar	9783
Rubber, Wire-braid	6.4 mm	0.9 m	1,400 bar	9755
Rubber, Wire-braid	6.4 mm	1.8 m	1,400 bar	9756
Rubber, Wire-braid	6.4 mm	1.8 m	1,400 bar	9754*
Rubber, Wire-braid	6.4 mm	2.4 m	1,400 bar	9757
Rubber, Wire-braid	6.4 mm	3.1 m	1,400 bar	9758

Hose Type	Hose I.D.	Hose Length	Burst Rating	Order No.
Rubber, Wire-braid	6.4 mm	3.7 m	1,400 bar	9759
Rubber, Wire-braid	6.4 mm	6.1 m	1,400 bar	9760
Rubber, Wire-braid	6.4 mm	9.2 m	1,400 bar	9761
Rubber, Wire-braid	6.4 mm	15.3	1,400 bar	9762
Rubber, Wire-braid	9.5 mm High Flow	0.9 m	1,400 bar	9733
Rubber, Wire-braid	9.5 mm High Flow	1.8 m	1,400 bar	9776
Rubber, Wire-braid	9.5 mm High Flow	3.1 m	1,400 bar	9777
Rubber, Wire-braid	9.5 mm High Flow	4.6 m	1,400 bar	9734
Rubber, Wire-braid	9.5 mm High Flow	6.1 m	1,400 bar	9778
Rubber, Wire-braid	9.5 mm High Flow	9.2 m	1,400 bar	9735
Rubber, Wire-braid	9.5 mm High Flow	12.2 m	1,400 bar	9736
Rubber, Wire-braid	9.5 mm High Flow	15.3 m	1,400 bar	9779
“Non-Conductive”	6.4 mm	1.8 m	2,800 bar	9773
“Non-Conductive”	6.4 mm	2.4 m	2,800 bar	9774
“Non-Conductive”	6.4 mm	6.1 m	2,800 bar	9775
CE	6.4 mm	0.6 m	2,800 bar	9765E
	6.4 mm	0.9 m	2,800 bar	9766E
	6.4 mm	1.8 m	2,800 bar	9767E
	6.4 mm	2.4 m	2,800 bar	9768E
	6.4 mm	3.1 m	2,800 bar	9769E
	6.4 mm	3.7 m	2,800 bar	9770E
	6.4 mm	6.1 m	2,800 bar	9771E

NOTE: Polyurethane hoses not recommended for use where heat or weld splatter conditions exist.
*Furnished with 9798 hose half coupler and 9800 dust cap.

Couplers

Standard and Flush-Face couplers

Oil
Page 78

Gauges
Page 76-77

Fittings
Page 80

Manifolds
Page 79

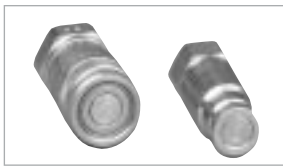

9794 Flush-Face couplers

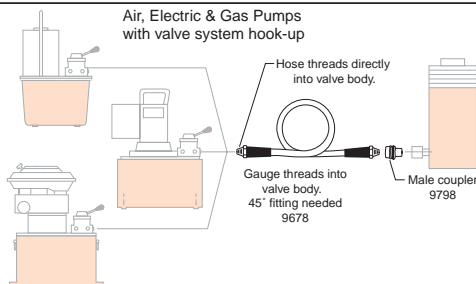
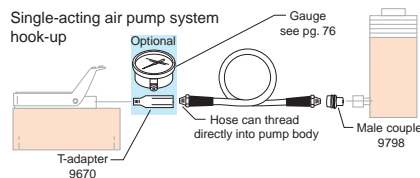
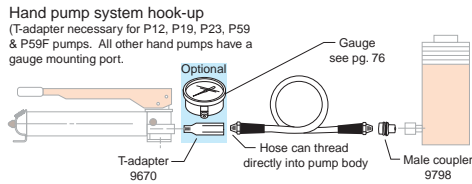
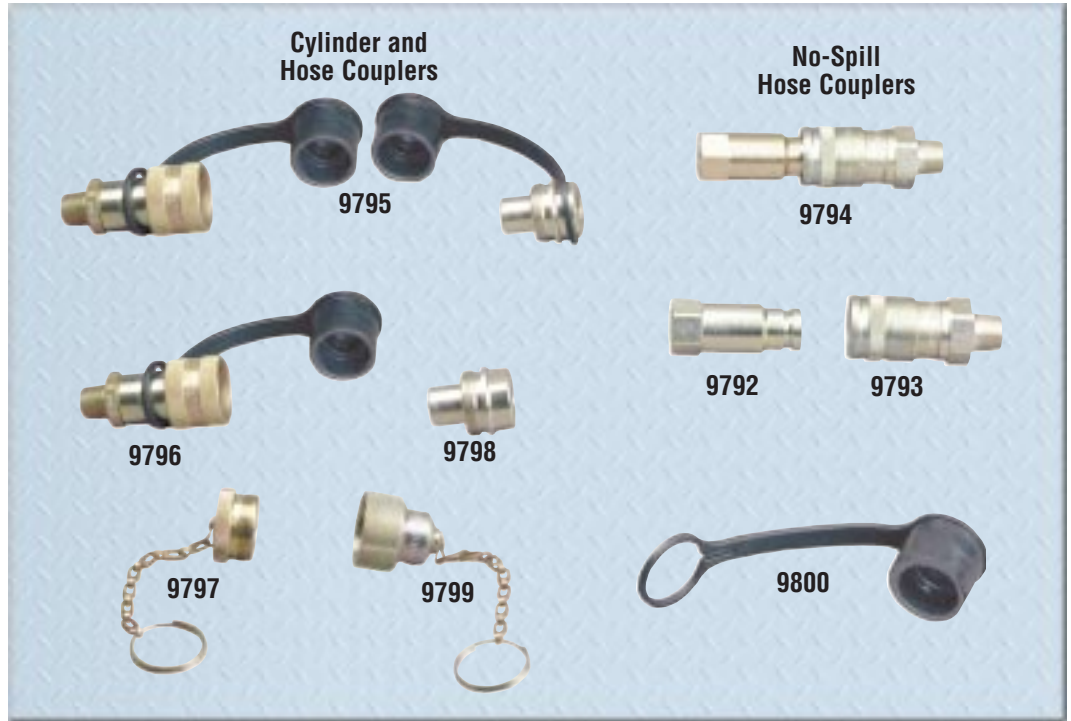

■ Cylinder and hose couplers

Designed for use up to 700 bar with hydraulic jacks, cylinders, etc. They are the threaded union type for interchanging cylinders in seconds. Each half is valved with a precision ball for a tight shutoff when disconnected. These couplers also permit the separation of cylinders or hose from pump when at 0 bar with minimal oil loss.

No. 9795 – Complete quick coupler, $\frac{3}{8}$ " NPTF. (Includes two 9800 dust caps.)

No. 9798 – Male (hose) half coupler (less hose half dust cap), $\frac{3}{8}$ " NPTF.

No. 9796 – Female (cylinder) half coupler with No. 9800 dust cap, $\frac{3}{8}$ " NPTF.

No. 9796-V – Same as 9796, but with Viton seals.

No. 9796-E – Same as 9796, but with EPR seals.

No. 9799 – Optional metal dust cap (Hose half.)

No. 9797 – Optional metal dust cap (Cylinder half.)

■ No-spill, push-to-connect hydraulic hose couplers

High flow, no-spill, push-to-connect couplers with locking collar and flush face designed for high pressure applications. The flush-face concept makes it easy to clean both coupler ends before connecting. Our unique push-to-connect, "dry-break" design eliminates oil spillage. The locking collar makes accidental disconnects a thing of the past. For 700 bar operation. Designed to permit high oil flow.

No. 9792 – Female (cylinder) half quick coupler only. Wt., 113 g.

No. 9793 – Male (hose) half quick coupler only. Wt., 113 g.

No. 9794 – Complete quick coupler (male and female). Dust caps not included. Wt., 227 g.

■ Hydraulic coupler dust cap

Dust cap fits either male or female half couplers.

No. 9800 – Dust cap. For male or female $\frac{3}{8}$ " NPTF half couplers. Wt., 113 g.

Gauges

Standard and digital gauges

HOSES, FITTINGS, GAUGES

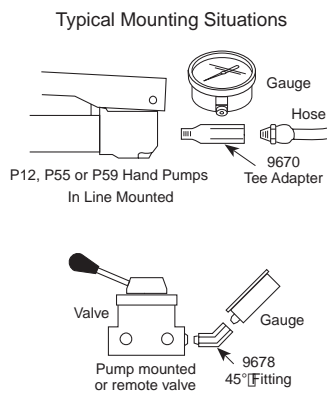

■ Heavy-duty hydraulic pressure gauges

These gauges feature an easily readable and highly visible adjustable, red day-glo needle. A high strength steel bourdon tube ensures high cycle life. With stainless steel cases and lens locking rings, all 102 mm and 152 mm dry gauges can be filled with silicone (Kit #9046). All gauges have 1/4" NPT bottom connections. Designed to meet ASME B40.1 grade B standards.

Note: Gauges 9040-9085 are available in Europe with readings in bar. To order, add the letter "E" to the part number (example 9075E) or contact your nearest Power Team facility.

■ Digital pressure gauges

Accurate to within 1%, these new gauges feature larger display characters than ordinary digital gauges. Each gauge includes a long-life pressure transducer with 1/4" NPTF male threads for the pressure connection and a 1.8 m signal input cable to connect to back of display unit.



FEATURES

- Pressure values are displayed on large red LED's in 10 psi or Bar increments.
- "Peak" hold feature with reset toggle switch and "Peak On" indicator; Hi/Low set point feature with relay outputs for Hi/Low alarms and/or control signals.
- A slow flashing display indicates pressure below the low limit; fast blinking display alerts you if high limit is exceeded.
- High and low limit relays are rated to a full 5 amps at 115 volts, compared to 1.5 amp rating of some competitive gauges.
- Operating temperature of -18 to 60°C for the electronic display and -29 to 82°C for the transducer. Gauge housings are extruded aluminum 1/8 DIN enclosures (NEMA 1 rating).
- When power cable is connected to gauge, display will scroll all characters, performing a self-diagnostic routine.

Digital Pressure Gauge

- No. DG100** – Digital pressure gauge, pressure range 0-10,000 psi. **Note:** Serviced only at factory. Wt., 1 kg.
- No. DG100B** – Metric digital pressure gauge, pressure range 0-690 Bar. **Note:** Serviced only at factory. Wt., 1 kg.

Digital Pressure Gauge Accessories

- No. 420778** – Gauge stand for DG100 or DG100B. Has angled base mounting to hold gauge at a convenient viewing angle. Wt., 0.5 kg. 
- No. 37045** – Auxiliary power cord for use with any 12 or 24V battery. Wt., 0.1 kg. **Caution:** For use on negative ground systems only. 

Standard Pressure Gauge Accessories

- No. 9046** – Silicone fill kit. 212 g. Requires one bottle to fill 102 mm gauge; four bottles to fill 152 mm gauge. 

Standard Pressure Gauge Accessories (cont.)

No. 9047 – Replacement lens and pointer for 63.5 mm dia. gauge.



No. 9048 – Replacement lens and pointer for 102 mm dia. gauge.



No. 9049 – High performance pulsation dampener. 1/4" NPTF male x 1/4" NPTF female.



STANDARD PRESSURE GAUGE ORDERING INFORMATION

Face Dia.	psi/Bar	Tons	Major Graduations	Minor Graduations	Silicone Filled	Use With Cylinder Series	Gauge No.
63.5 mm	0-10,000/0-690	–	2500 psi, 100 Bar	500 psi, 20 Bar	No	All	9041
63.5 mm	0-10,000/0-690	–	2500 psi, 100 Bar	500 psi, 20 Bar	Yes	All	9040
101.6 mm	0-10,000/0-690	–	1000 psi, 100 Bar	200 psi, 10 Bar	No*	All	9051
101.6 mm	0-10,000/0-690	–	1000 psi, 100 Bar	200 psi, 10 Bar	Yes	All	9052
101.6 mm	0-10,000/0-690	0-17.5, 0-30 and 0-50	2000 psi, 5 Ton	200 psi, .5 Ton on 30, 50 Ton Scales; .2 Ton on 17.5 Ton Scale	No*	RT172, RT302, RT503	9059
101.6 mm	0-10,000/0-690	0-5	2000 psi, 1 Ton	200 psi, .1 Ton	No	C & RLS	9053
101.6 mm	0-10,000/0-690	0-10	2000 psi, 1 Ton	200 psi, .1 Ton	No*	C, RD, RH, RLS & RSS	9055
101.6 mm	0-10,000/0-690	0-15	2000 psi, 1 Ton	200 psi, .2 Ton	No*	C	9057
101.6 mm	0-10,000/0-690	0-20	2000 psi, 5 Ton	200 psi, .2 Ton	No*	RH†, RLS, RSS	9061
101.6 mm	0-10,000/0-690	0-25	2000 psi, 5 Ton	200 psi, .5 Ton	No*	C & RD	9063
101.6 mm	0-10,000/0-690	0-30	2000 psi, 5 Ton	200 psi, .5 Ton	No*	RH†, RLS & RSS	9065
101.6 mm	0-10,000/0-690	0-50	2000 psi, 5 Ton	200 psi, .5 Ton	No*	RH†, RLS & RSS	9067
101.6 mm	0-10,000/0-690	0-55	2000 psi, 5 Ton	200 psi, .5 Ton	No*	C, R, RA & RD	9069
101.6 mm	0-10,000/0-690	0-60	2000 psi, 5 Ton	200 psi, 1 Ton	No*	RH	9071
101.6 mm	0-10,000/0-690	0-75	2000 psi, 5 Ton	200 psi, 1 Ton	No*	C, RLS & RD8013	9073
101.6 mm	0-10,000/0-690	0-100	2000 psi, 10 Ton	200 psi, 1 Ton	No*	C, R, RA, RD, RH, RLS†, RSS† & RT1004†	9075
101.6 mm	0-10,000/0-690	0-150	2000 psi, Initial 10 Then 20 Ton	200 psi, 2 Ton	No*	C, R, RD & RLS	9077
101.6 mm	0-10,000/0-690	0-200	2000 psi, 20 Ton	200 psi, 2 Ton	No*	R, RD & RH†	9079
101.6 mm	0-10,000/0-690	0-300	2000 psi, 25 Ton	200 psi, 5 Ton	No*	RD	9081
101.6 mm	0-10,000/0-690	0-400	2000 psi, 50 Ton	200 psi, 5 Ton	No*	RD	9083
101.6 mm	0-10,000/0-690	0-500	2000 psi, 50 Ton	200 psi, 5 Ton	No*	RD	9085
101.6 mm	0-6,000/0-400	0-400	1000 psi, 100 Bar	200 psi, 10 Bar	No*	All	9087
101.6 mm	0-10,000/0-690	0-150	2000 psi, Initial 10 Then 20 Ton	200 psi, 2 Ton	Yes	RH	9091
152.4 mm	0-10,000/0-690	0-690	1000 psi, 100 Bar	100 psi, 10 Bar	No*	All	9089

* Shipped “dry”. User can convert to “wet” using liquid silicone No. 9046.

† The tonnage scale on the gauge is based on a different effective area. A slight error in tonnage reading will occur relative to the different effective area.

Hydraulic Fluids

Standard, Flame-Out®, Biodegradable and Low Temp.



■ Standard hydraulic oil

For dependable performance of all your hydraulic pumps and cylinders you need this specially formulated, high grade hydraulic fluid. It contains foam suppressant additives and has a high viscosity index. Refer to table below for specifications.

■ Flame-Out® 220 fire resistant hydraulic fluid

This synthetic hydraulic fluid contains anti-rust, anti-foam and anti-sludge additives while providing fire resistant protection. It provides maximum lubrication and heat transfer and can be used in a wide operating temperature range. With Flame-Out fluid you do not have to change seals in your Power Team equipment. When you need this fluid, just drain the standard oil and replace it with Flame-Out 220.

(Note: Fire resistant fluids will burn if heat source is extreme enough. They will not, however, propagate the flame and are self-extinguishing when there is no ignition source.)

■ “Environmentally friendly” hydraulic fluid

- Biodegradable, non-toxic fluid withstands moderate to severe operating conditions; provides excellent protection against rust.
- Balanced formulation prevents corrosion, offers superior anti-wear properties, has excellent multi-metal compatibility.

Developed to meet stringent performance requirements and satisfy growing environmental needs for hydraulic fluids which are readily biodegradable and non-toxic. Can be used with all Power Team pumps, cylinders, valves and other accessories using our standard seals. Depending on the contamination or degradation levels which might be present in used fluid, small amounts of this substance, if spilled, will not affect ground water or the environment. Acceptable methods of disposal include use as a fuel supplement. Since this fluid will not typically be hazardous waste, additional disposal options may be available, including land farming or processing through sewage treatment facilities, if necessary approvals are obtained from appropriate regulatory authorities. This fluid has been tested against EPA 560/6-82-003 and OECD 301 for biodegradability, and toxicity has been tested against EPA 560/6-82-002 and OECD 203: 1-12. Not recommended for operation in temperatures below -7°C (20°F) or above 71°C (160°F). Recommended storage temperatures not below -23°C (-10°F) or above 77°C (170°F). For additional technical information or to order a Material Safety Data Sheet call 1-800-477-8326.

■ Low-temperature oil

Provides smooth, reliable operation in the coldest climate conditions.

Oil Description	Qty.	Order No.
Standard Oil	.9 L (934 cu. cm.)	9636
Standard Oil	3.8 L (3786 cu.cm.)	9637
Standard Oil	9.5 L (9457 cu. cm.)	9638
Standard Oil	208 L	9616
Flame Out®	3.8 L (3786 cu.cm.)	9639
Flame Out®	9.5 L (9457 cu. cm.)	9640
Biodegradable	3.8 L (3786 cu.cm.)	9645
Biodegradable	9.5 L (9457 cu. cm.)	9646
Low-Temp.	3.8 L (3786 cu.cm.)	9647

SPECIFICATIONS

Description	Grade (ASTM)	Specific Gravity @ 16°C (60°F)	Color (ASTM)	Flash Point	Fire Point	Pour Point	Viscosity		Viscosity Index	Foam Test (ASTM)
							SUS @ 38°C (100°F)	SUS @ 99°C (210°F)		
Standard Oil	215	.88	2.0	204°C (400°F)	221°C (430°F)	-34°C (-30°F)	215	48	100 min.	Pass
Flame Out®	220	.91	Light Amber	260°C (500°F)	228°C (550°F)	-26°C (-15°F)	220	55	140 min.	Pass
Biodegradable	—	.92	2.0	224°C (432°F)	NA*	-30°C (-22°F)	183	53	213 min.	Pass
Low-Temp.	—	.87	6.5 (Red)	180°C (356°F)	204°C (399°F)	-45°C (-48°F)	183	52	190 min.	Pass

*Not available

Manifolds

Remote and pump mounted

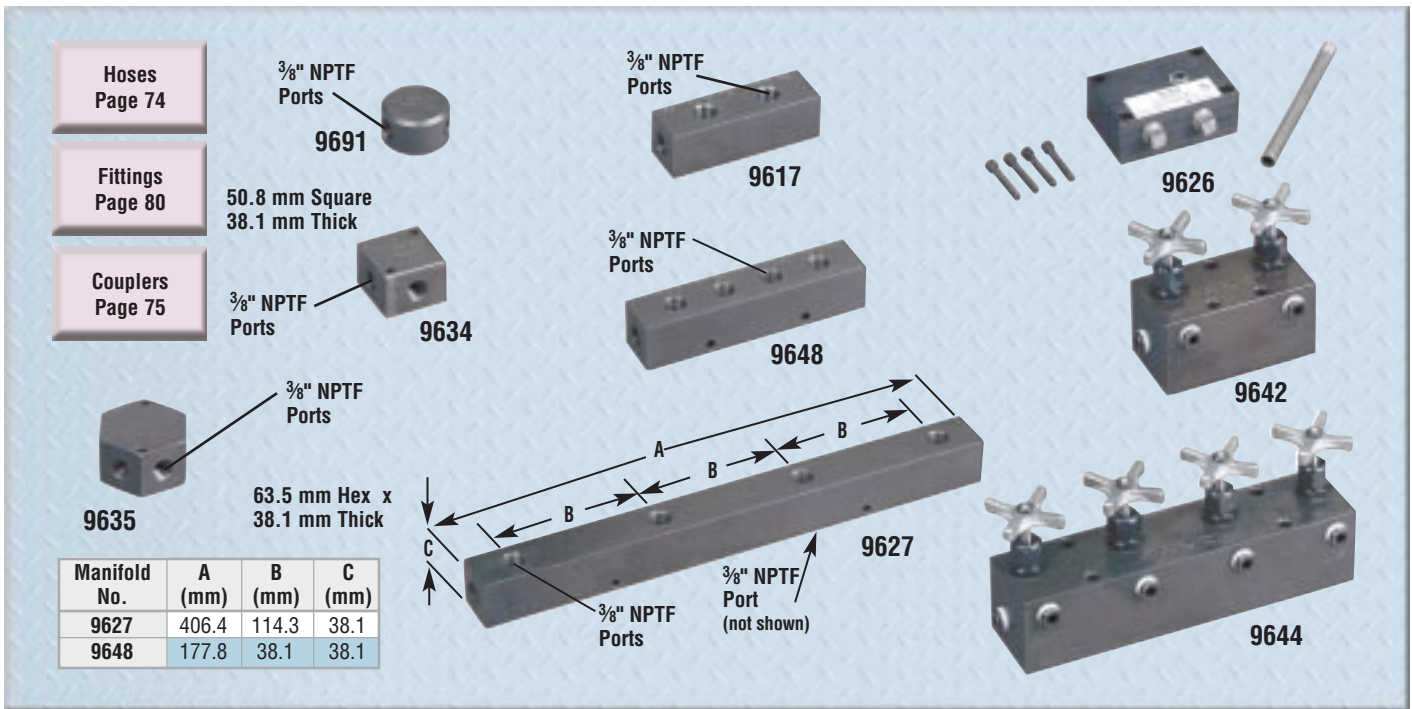

No. 9691 – “Y” Manifold

Extremely useful when connecting two hydraulic cylinders to a single line. Has three 3/8" NPTF ports. Wt., 0.5 kg.

No. 9634 – Manifold block

This manifold is for multiple-cylinder installation, has four 3/8" NPTF ports and two 6.4 mm mounting holes. Wt., 0.7 kg.

No. 9635 – Manifold block

This hex-shaped manifold offers extra versatility, has six 3/8" NPTF ports and two 6.4 mm mounting holes. Wt., 0.9 kg.

No. 9617 – Manifold block

When a multiple-cylinder installation is required, this manifold is invaluable. Has six 3/8" NPTF ports to handle larger multiple-cylinder systems. Wt., 1.4 kg.

No. 9648 – Manifold block

This 177.8 mm long manifold block has seven 3/8" NPTF ports and two 6.4 mm mounting holes. Wt., 1.2 kg.

No. 9627 – Manifold block

This 406.4 mm long manifold block allows you to mount the 9575 or 9596 valves without interference. Has seven 3/8" NPTF ports and two 6.4 mm mounting holes. Wt., 2.7 kg.

No. 9626 – Pump mounted manifold block

It converts Power Team pumps with pump mounted valves for use with remote mounted valves. This manifold block is subplate mounted on the pump cover plate and provides 3/8" NPTF pressure and return ports. Maximum operating pressure is 700 bar. and maximum recommended flow rate is 19 L/min.

Note: If used on PE30 or PG30 series pump, 12.7 mm longer mounting screws are required. Order four (4) No. 11956 screws separately.

■ 9642 and 9644 Manifold blocks with needle valves

For independent multiple-cylinder operation, feature needle valves for precise manual control. Designed for remote-mounted applications, they can be used with all Power Team gas, air or electrically driven hydraulic pumps.

No. 9642 – Manifold with two needle valves for control of two cylinders. Has four 3/8" NPTF ports. Wt., 3.7 kg.

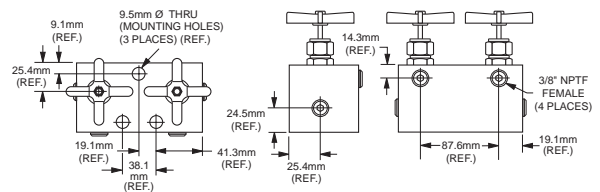



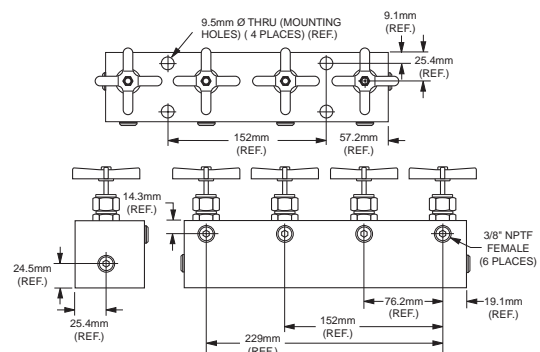



No. 9644 – Manifold with four needle valves for control of four cylinders. Has six 3/8" NPTF ports. Wt., 7.4 kg.



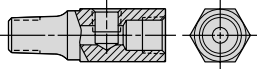
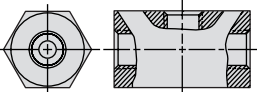
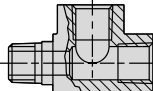
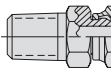
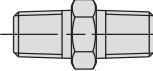
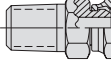

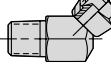
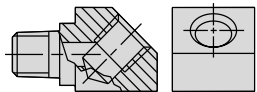
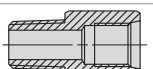
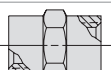
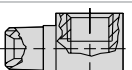

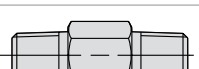

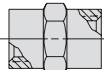

Hydraulic Fittings

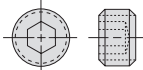
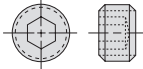
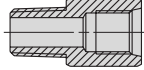
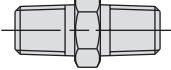
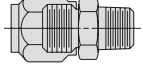
700 bar

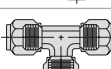
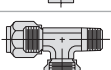
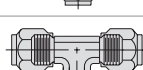
Power Team's fittings include a wide range of types and sizes. Ideal for many hydraulic applications.

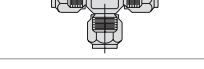
Order No.	Description
 9190	Hyd. tubing. $\frac{3}{8}$ " O.D. x $\frac{21}{32}$ " wall, 15.3 m. (10 pieces 1.53 m long.) Wt., 5.5 kg.
 9670	Tee adapter. For installing gauge between pump and hose coupling. Has $\frac{1}{4}$ " and $\frac{3}{8}$ " NPTF female and $\frac{3}{8}$ " NPTF male ports. Wt., 226 g.
 9671	Double tee adapter. Permits use of more than one cylinder in series with one pump. Three $\frac{3}{8}$ " NPTF female ports. Wt., 453 g.
 9672	Service tee. Two $\frac{3}{8}$ " NPTF female internal, one $\frac{3}{8}$ " NPTF male external. Wt., 272 g.
 9673*	Swivel connector. $\frac{3}{8}$ " NPSM male, $\frac{1}{4}$ " NPSM female. Wt., 91 g.
 9674	Male connector. 43 mm long, $\frac{1}{4}$ " x $\frac{3}{8}$ " NPTF. Wt., 91 g.
 9675*	Swivel connector. $\frac{3}{8}$ " NPTF male, $\frac{3}{8}$ " NPSM female. Wt., 91 g.
 9676*	Swivel connector. $\frac{1}{4}$ " NPTF male, $\frac{3}{8}$ " NPSM female. Wt., 91 g.
 9677*	45° swivel connector. $\frac{3}{8}$ " NPTF male, $\frac{3}{8}$ " NPSM female. Wt., 136 g.
 9678	45° fitting. Used when mounting gauge at an angle on connection such as 9670. Male and female $\frac{1}{4}$ " NPTF ends. Wt., 136 g.
 9679	Connector. $\frac{1}{4}$ " NPTF female and $\frac{3}{8}$ " NPTF male. Wt., 45 g.
 9680	Coupling. Both ends $\frac{3}{8}$ " NPTF female. Wt., 91 g.
 9681	Street elbow. Male and female $\frac{3}{8}$ " NPTF ends. Wt., 136 g.
 9682	Male connector. 43 mm long, $\frac{3}{8}$ " NPTF male ends. Wt., 45 g.
 9683	Male connector. 57 mm long, $\frac{3}{8}$ " NPTF male ends. Wt., 91 g.
 9684	Male connector. 57 mm long, $\frac{1}{4}$ " NPTF male ends. Wt., 91 g.

 9685	Coupling. $\frac{1}{4}$ " NPTF female and $\frac{3}{8}$ " NPTF female. Wt., 91 g.
 9686	90° elbow. $\frac{3}{8}$ " NPTF female ends. Wt., 181 g.
 9687	Pipe plug. Heat-treated, $\frac{3}{8}$ " NPTF. Wt., 45 g.
 9688	Pipe plug. Heat-treated, $\frac{1}{4}$ " NPTF. Wt., 45 g.
 9689	Connector. $\frac{1}{4}$ " NPTF male and $\frac{3}{8}$ " NPTF female. Wt., 91 g.
 9690	Male connector. 43 mm long, $\frac{1}{4}$ " NPTF male ends. Wt., 45 g.
 9692	Straight connector. $\frac{3}{8}$ " tube x $\frac{3}{8}$ " male NPTF. Wt., 0.2 lb.
 9693	90° elbow. $\frac{3}{8}$ " tube x $\frac{3}{8}$ " male NPTF. Wt., 91 g.
 9694	45° elbow. $\frac{3}{8}$ " tube x $\frac{1}{4}$ " male NPTF. Wt., 91 g.
 9695	Tee. $\frac{3}{8}$ " tube. Wt., 136 g.
 9696	Male run tee. $\frac{3}{8}$ " tube x $\frac{1}{4}$ " male NPTF. Wt., 136 g.
 9697	Male branch tee. $\frac{3}{8}$ " tube x $\frac{1}{4}$ " male NPTF. Wt., 136 g.
 9698	Cross. $\frac{3}{8}$ " tube. Wt., 181 g.
 9699	45° gauge fitting. $\frac{3}{8}$ " NPTF male and female, and $\frac{1}{4}$ " NPTF female at 45°. Wt., 272 g.
 9705	Fitting, swivel. $\frac{3}{8}$ " NPTF male to $\frac{3}{8}$ " NPTF female. 90° fitting with internal 370 micron screen. May be rotated 360° about male thread axis.

NOTE: Power Team hydraulic fittings are intended for use with our high pressure hydraulic products and are suitable for use at max. working pressures of 700 bar unless otherwise noted.

CAUTION: On part numbers 9673, 9675, 9676 and 9677 the female swivel end of these adapters is a straight pipe thread (NPSM) with a 30° seat. All male pipe fittings that are used with these female swivel adapters must have an internal 30° seat in order to effect a proper seal. All Power Team male fittings are manufactured with a 30° seat except 9687 and 9688.

HOSES, FITTINGS, GAUGES